

integraliftTM



*A Safe patient
handling revolution*

by
integra

*Designed to see
the person*

*Lean workflow
enhances safety*

Improving the patient experience

Creating
the right space
for care & comfort

Integralift is a revolutionary new patient lift. It is “designed to see the person” and that is why the product fits in, is out of the way and communicates well-being

Scandinavian design
Designed and produced in Norway

Research findings support the assumption that positive environments and well-being is a central part of the healing process



A lean workflow for enhanced safety

SAVE TIME 1 GET STARTED

Integralift is ready for action positioned just besides each bed



All necessary gear is ergonomically situated in the dedicated nurse closet.

SAVE TIME 2 SHORT TRANSFER

Easy point to point transfer with flexible drop-points and minimum sling-time. Initiation and completion procedures faster than all comparable systems

SAVE TIME 3 READY

Integralift is directly connected to the mains powered. This saves time and makes the transfer procedure shorter

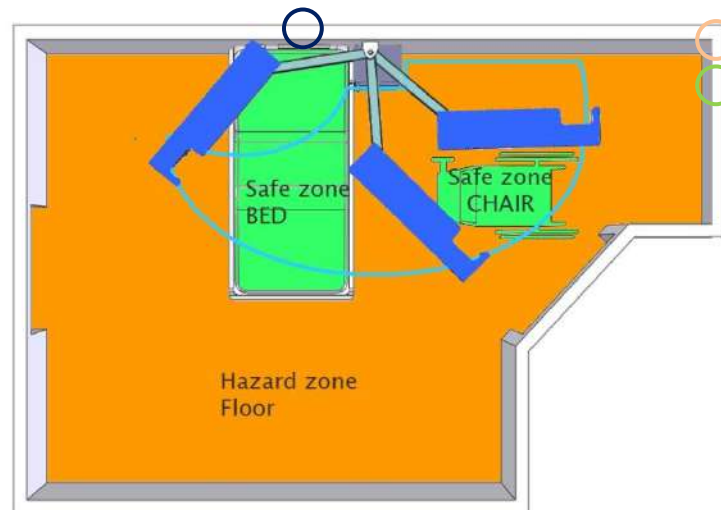
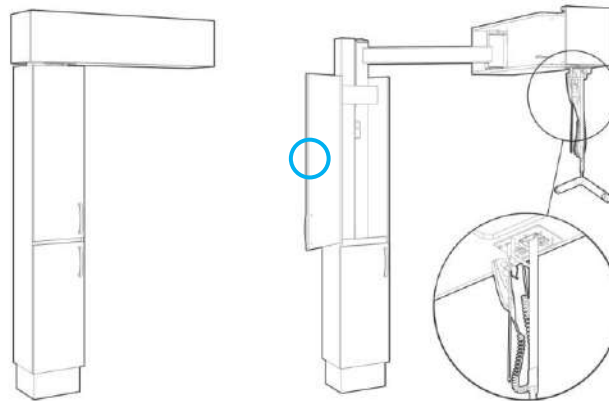

Improving efficiency
Increasing safety

SAFETY 1 SHORT TRANSFER
Minimize sling-time to avoid patient stress and to avoid pressure ulcers

SAFETY 2 SHORT TRANSFER
Minimize sling-time over the floor
To avoid accidents



SAFETY EQUIPMENT REQUIREMENTS

- Available at a fixed place
- Fast to activate
- Easy to use
- Near impossible to misuse (e.g. prolonged sling-time)

WHAT IS LEAN WORKFLOW?

Making the work flow naturally. Avoid waste and promote procedures that are simple, ergonomic and safe.

Next generation room solution

integralift
space for

Integralift offers unprecedented opportunities for integrated room-solutions

Integrate

- **Integralift**
- lightning
- headwall- functionality
- room-divider
- IT solutions

Matching bed, bedside- table, ipad arm, furnishing and interior

EVIDENCE-BASED DESIGN (EBD)

EBD is one of the major trends within healthcare construction. EBD focuses on improving patient and staff well-being, patient healing, stress reduction and safety



Flexible planning for lean construction

FACILITY PLANNING

1. Efficient workflow
2. Interior design
3. Lean construction

IDEAL FOR

- home-care
- resident housing
- long term care
- hospital bed-wards
- hospices and hotels

Integralift has a flexible mounting system that fits perfectly with both prefab-pods, modular construction and in retro-fitting for refurbishing projects and in homecare

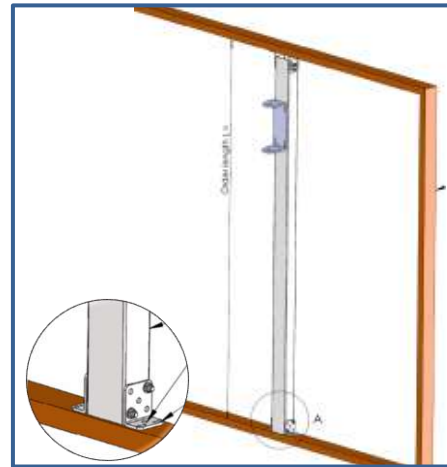
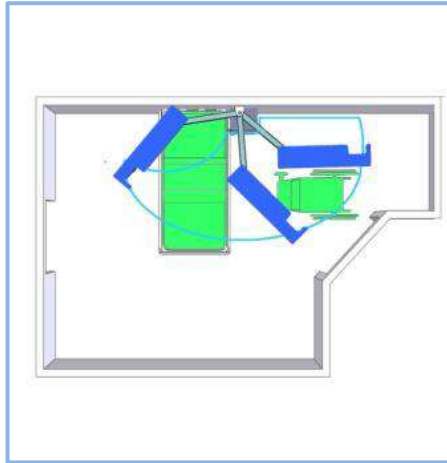

Contact our dealers for further assistance or go to our website Integralift.net.

Tip : Integrate our Inside wall structures (IW) inside the walls and future-proof the facility for the needs of tomorrow. Economical, integrated and future proof

Tip: *All ceilings allowed !*



How it works

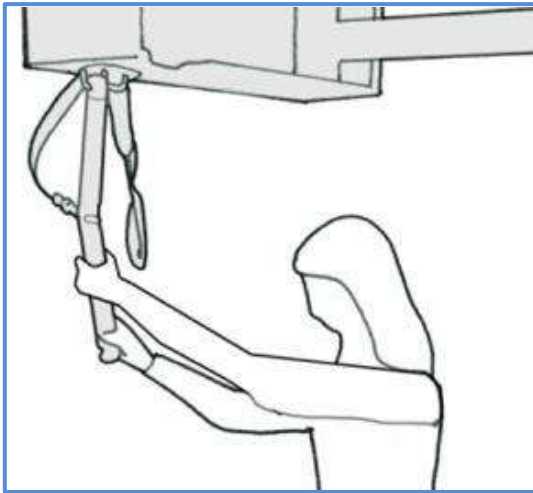

ACTIVATE

Open the nurse-closet and pull out the lift
Position the lift above the user

PLACE THE SLING

Position the sling under the user
Hook the sling on to the lifting bar
Make sure the lifting straps are inside the grooves of the lifting bar

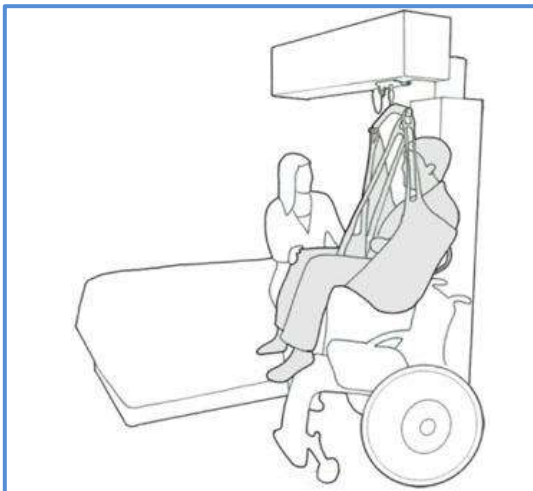
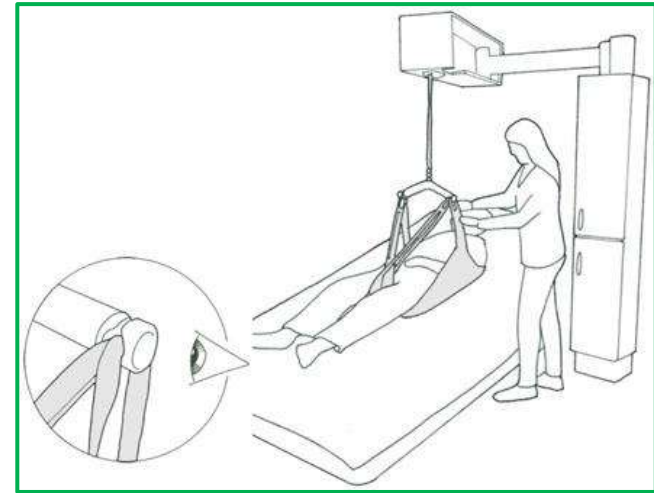

DO THE TRANSFER

Lift the user and
Position the user over the chair
Lower the user gently into the chair

AFTER THE TRANSFER

Place the lifting bar and the hand control in their designated places
Swing the lift back to its wall position
Put the sling back in the closet

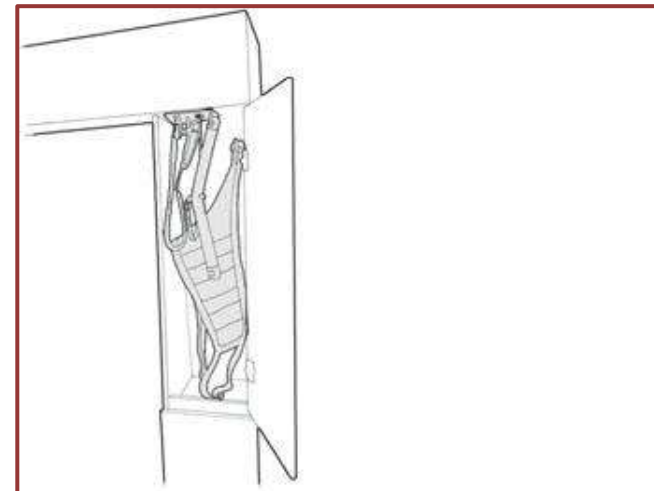

Technical



Warranty	2 years
Maximum load	230 kg
Battery	24 V DC, 4,5 Ah, sealed lead battery
Battery charger	100-240 VAC, 50-60 Hz, max 1.300 mA
Lifting speed	50-70 mm/sec.
Lifting interval	1,8 m (vertically adjustable)

Diameter of action	3 m
Radius of action	1,5 m
Soft start & soft stop	
Emergency stop	Electrical
Emergency lowering	Electrical and mechanical

Protection class IP 20
 Integralift is a quality product and certified in accordance with:
 ISO 10535:2006(E)
 IEC 60601-1 Ed. 3.0 b:2005
 IEC 60601-1-2 Ed. 3.0 b:2007
 Class I equipment in accordance with MDD 93/42/EEC

integralift™

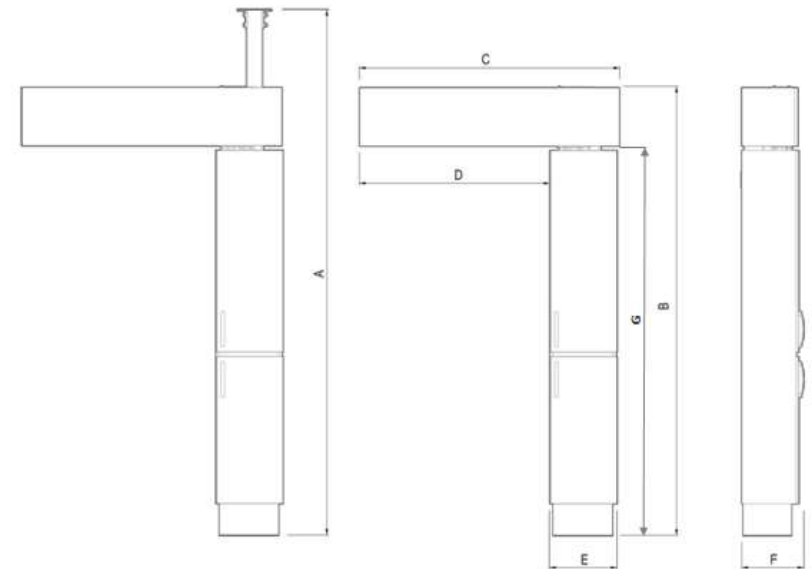

Model	Capacity	A	B	C	D	E	F	G
WM-230	230 kg	220	226	124	89	35	30	197
FC-230	230 kg	230-330						
IW-230	230 kg	230-500						

All measurements (A-G) in centimeters.

